

カベ取付型

A型	C A型
----	------

出力上側

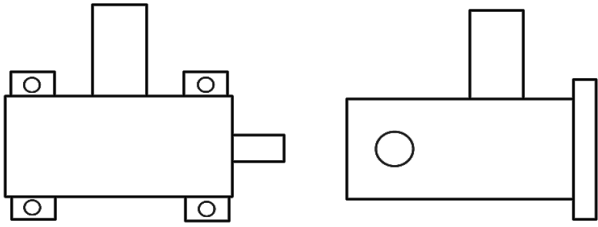

出力下側

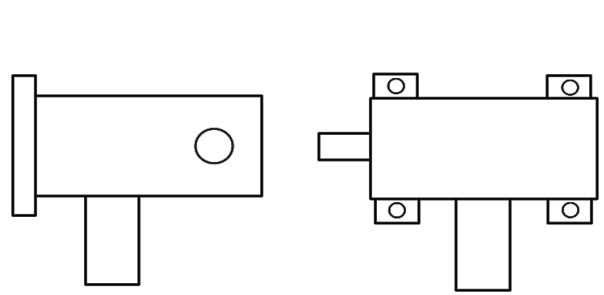

入力上側

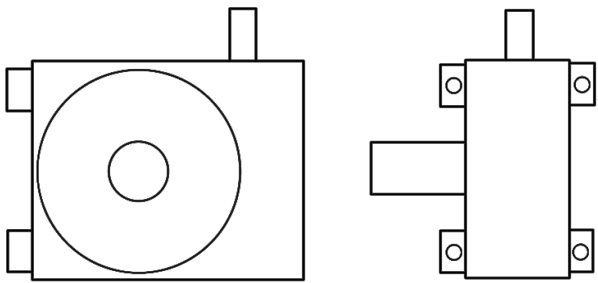

入力下側

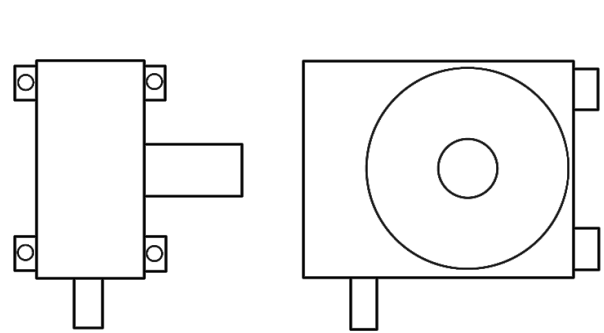

B A型

入力上側横出

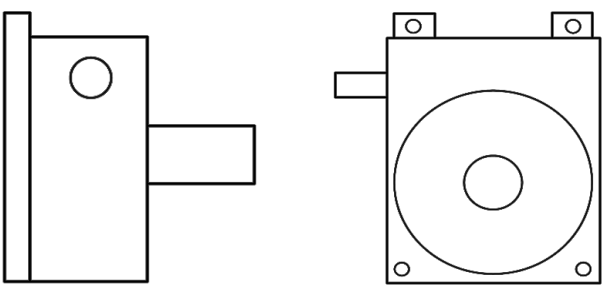

入力下側横出

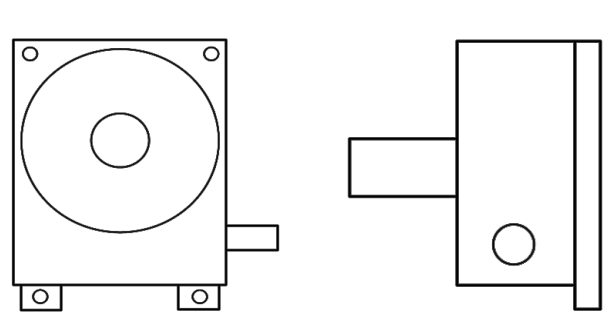

入力上側上出

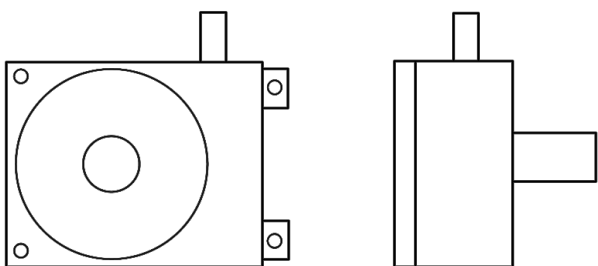

入力下側下出

